

Instructions for use

Translation of the original operating manual



CE
perfecta
900

Contents

W&H Symbols	3 – 5
1. Introduction	6 – 7
2. Unpacking	8
3. Equipment supplied	9 – 10
4. Safety notes	11 – 12
5. Description / Assembly / Starting operation – Knee control unit	13 – 15
6. Description / Starting operation – Table control unit	16 – 18
7. General starting operation – Filling of the coolant tank / Regulating coolant	19 – 20
8. Description of the motor handpiece LA-9 / LA-66 (optional) / Adaptor for milling device (optional)	21 – 22
9. General operation – Motor handpiece / Blow out function	23
10. Description of the operating controls / Assemble support (optional)	24 – 25
11. Operating the operating controls – Reverse operation / Changing the speed / Changing motor handpiece / Coolant spray / Bistable operation / Speed control operation	26 – 30
12. Removing and assembling the motor handpiece	31
13. Changing the rotary tools	32 – 33
14. Cleaning	34
15. Cleaning / changing the chuck	35 – 36
16. Error messages	37
17. W&H Accessories	38
18. Servicing	39
19. Technical Data	40 – 41
20. Recycling and Disposal	42
Letter of indemnity	43
CE-Declaration of conformity	44
Authorized W&H service partners	45

W&H Symbols

Symbols in the instructions for use



WARNING!
[Risk of injury]



ATTENTION!
[to prevent damage occurring]



General explanations,
without risk to
persons or objects











W&H Service

Only for USA

Caution: Federal law restricts this device to sale by or on the order of a dentist, physician or any other practitioner licensed by the law of the state in which he or she practices to use or order the use of the device.

W&H Symbols

Symbols on the control unit

	Consult instructions for use		Do not dispose of with domestic waste	REF	Catalogue number
	Date of manufacture		Foot switch	SN	Serial number
	Electric fuse		Motor	V	Supply voltage of the unit
	Data Matrix Code, only for certain models, for product identification		Operating controls	AC	Alternating current
				VA	Electric power input of the unit
				A	Supply current
				Hz	Frequency of the alternating current

W&H Symbols

Symbols on the packaging



This way up

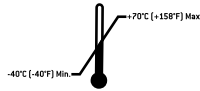

Temperature limit

R_x_{only}

Caution: Federal law restricts this device to sale by or on the order of a dentist, physician or any other practitioner licensed by the law of the state in which he or she practices to use or order the use of the device



Fragile, handle with care



Humidity limitation



Keep away from rain



CE from manufacturer





Der Grüne Punkt
Identification mark of Duales
System Deutschland AG



General symbol for
recovery/recyclable

1. Introduction

 **For your safety and the safety of your team**
These Instructions for use explain how to use your W&H product. However, we must also warn against possible hazardous situations. Your safety and the safety of your team are of paramount importance to us.

 It is therefore essential to read the safety notes on Pages 11 to 12.

Intended use

The control unit is intended for rotating or machining use with all material processed in a dental laboratory, whereby the handpiece is guided by hand.

 The control unit is **not** designed as a piece of **medical** equipment!
It is not permitted for use on patients!

Skilled application

The Perfecta is intended only for skilled application in the dental or medical field according to its purpose of use in compliance with the valid health and safety at work regulations, the valid accident prevention regulations as well as in compliance with these instructions for use. Non-compliance with these instructions or use of accessories and spare parts that are not approved by W&H invalidate all claims under warranty and any other claims.

Introduction

The Perfecta is in the condition as supplied by us

- > safety checked
- > carries the UL mark of quality
- > suppressed in accordance with pertinent standards.

This declaration is not valid for unintended external or internal attachments and the like.

 **Responsibility of the manufacturer**
W&H Dentalwerk Bürmoos can only accept responsibility for the safety, reliability and performance of the Perfecta when there is compliance with the following directions:

-  > Consult Instructions for use
- > The Perfecta has no components which can be repaired by the user. Assembly, modifications or repairs must only be undertaken by an authorized W&H service partner (see page 45).
 - > Unauthorised opening of the equipment invalidates all claims under warranty and any other claims.

2. Unpacking

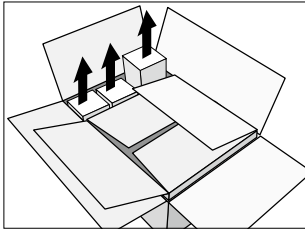

❶ Lift out the accessories carton.

W&H packaging is environmentally friendly and can be disposed of through branch recycling companies.

However, we recommend that you keep the original packaging.

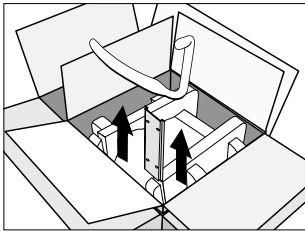

❷ Knee control unit: Remove the holding plate and fitting for the blow out function.

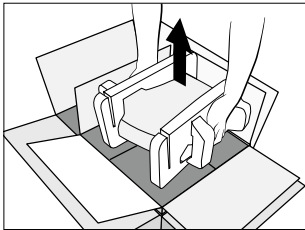

❸ Lift out insert with control unit.

3. Perfecta 900 equipment supplied with internal coolant supplying

<p>Knee control unit</p> <p>Control unit:</p> <ul style="list-style-type: none"> ○ REF 05223900 230 V ○ REF 05224000 115 V <ul style="list-style-type: none"> ○ Operating controls LA-9D REF 05243400 ○ Fitting for blow out function REF 05148800 ○ Holding plate REF 01170500 ○ Tapping screws REF 00952200 	<p>Table control unit</p> <p>Control unit:</p> <ul style="list-style-type: none"> ○ REF 05223500 230 V ○ REF 05223600 115 V <ul style="list-style-type: none"> ○ Operating controls LA-9D REF 05243400 ○ Foot-operated starter L-NV REF 05038100 ○ Foot stand for control unit REF 04820800 	<p>Knee-, Table control unit</p> <ul style="list-style-type: none"> ○ Motor cable 1.8 m for LA-9 REF 05117800 ○ Hose for air supply REF 05250400 ○ Motor handpiece LA-9 (without motor cable) REF 05015900 ○ Handpiece holder REF 03211500 <p>optional:</p> <ul style="list-style-type: none"> ○ <i>Motor cable 1.8 m for LA-66 REF 05116500</i> ○ <i>Motor handpiece LA-66 (without motor cable) REF 05201200</i> ○ <i>Chuck key REF 01125900</i> ○ <i>Spanner REF 03202800</i> ○ <i>W&H Service oil REF 03304500</i> ○ <i>Cleaning brush REF 00669400</i> <ul style="list-style-type: none"> ○ Mains cable REF 01343700 (Europa) <p>alternativ:</p> <ul style="list-style-type: none"> ○ Mains cable REF 01343900 (USA, CAN, J) / REF 03212700 (UK, IRL) / REF 02909300 (AUS, NZ) / REF 04280600 (CH)
--	---	--

Perfecta 900 equipment supplied with external coolant supplying

<p>Knee control unit</p> <p>Control unit:</p> <ul style="list-style-type: none"> ○ REF 05333600 230 V ○ REF 04542400 115 V <ul style="list-style-type: none"> ○ Operating controls LA-9D REF 05243400 ○ Fitting for blow out function REF 05148800 ○ Holding plate REF 01170500 ○ Tapping screws REF 00952200 	<p>Table control unit</p> <p>Control unit:</p> <ul style="list-style-type: none"> ○ REF 05334200 230 V ○ REF 05334300 115 V <ul style="list-style-type: none"> ○ Operating controls LA-9D REF 05243400 ○ Foot-operated starter L-NV REF 05038100 	<p>Knee-, Table control unit</p> <ul style="list-style-type: none"> ○ Motor cable 1.8 m for LA-9 REF 05117800 ○ Hose for air supply REF 05250400 ○ Hose for coolant supply REF 05075600 <ul style="list-style-type: none"> ○ Motor handpiece LA-9 (without motor cable) REF 05015900 ○ Handpiece holder REF 03211500 <p>optional:</p> <ul style="list-style-type: none"> ○ <i>Motor cable 1.8 m for LA-66 REF 05116500</i> ○ <i>Motor handpiece LA-66 (without motor cable) REF 05201200</i> ○ <i>Chuck key REF 01125900</i> ○ <i>Spanner REF 03202800</i> ○ <i>W&H Service oil REF 03304500</i> ○ <i>Cleaning brush REF 00669400</i> ○ Mains cable REF 01343700 (Europa) <p>alternativ:</p> <ul style="list-style-type: none"> ○ Mains cable REF 01343900 (USA, CAN, J) / REF 03212700 (UK, IRL) / REF 02909300 (AUS, NZ) / REF 04280600 (CH)
--	---	--

4. Safety notes



Please ensure that you carry out the following instructions

- > Before using the Perfecta for the first time, store it at room temperature for 24 hours.
- > Only connect the Perfecta to a socket outlet with protective earthing.
- > Never touch rotary instruments which are still rotating.
- > Never touch the chuck mechanism / twist chuck of the motor handpiece while they are still running.
- > Comply with the necessary protective measures such as the wearing of safety goggles, use of protective screens etc.
- > Always observe the contents of the safety data sheet for the material you are working with.
- > The Perfecta is intended for use at a dental technician's workstation (suction, protective equipment).



Use only suitable and serviceable tools

Use only good quality rotary tools which comply with EN ISO 1797-1. Ensure that you comply with the tool manufacturer's instructions with respect to maximum speed, maximum torque, forward and reverse movement!

Inappropriate use

Improper use, in addition to incorrect assembly, installation, modification or repairs of the Perfecta or non-compliance with our instructions invalidates all claims under warranty and any other claims.

The control unit is only permitted for use in confined spaces (indoor use)!

Safety notes

 **Danger zone**
The control unit is not suitable for use in areas in which special conditions prevail (e.g. corrosive or explosive atmospheres).

Power failure

In the event of a power failure or if the Perfecta is switched off, the last speed set is saved and re-activated on power-up.

Intermittent operating mode S6 (4min/10min) is the designation for continuous operation with intermittent loading. The recommended loading time is 4 minutes at a running time of 10 minutes.

5. Description of knee control unit

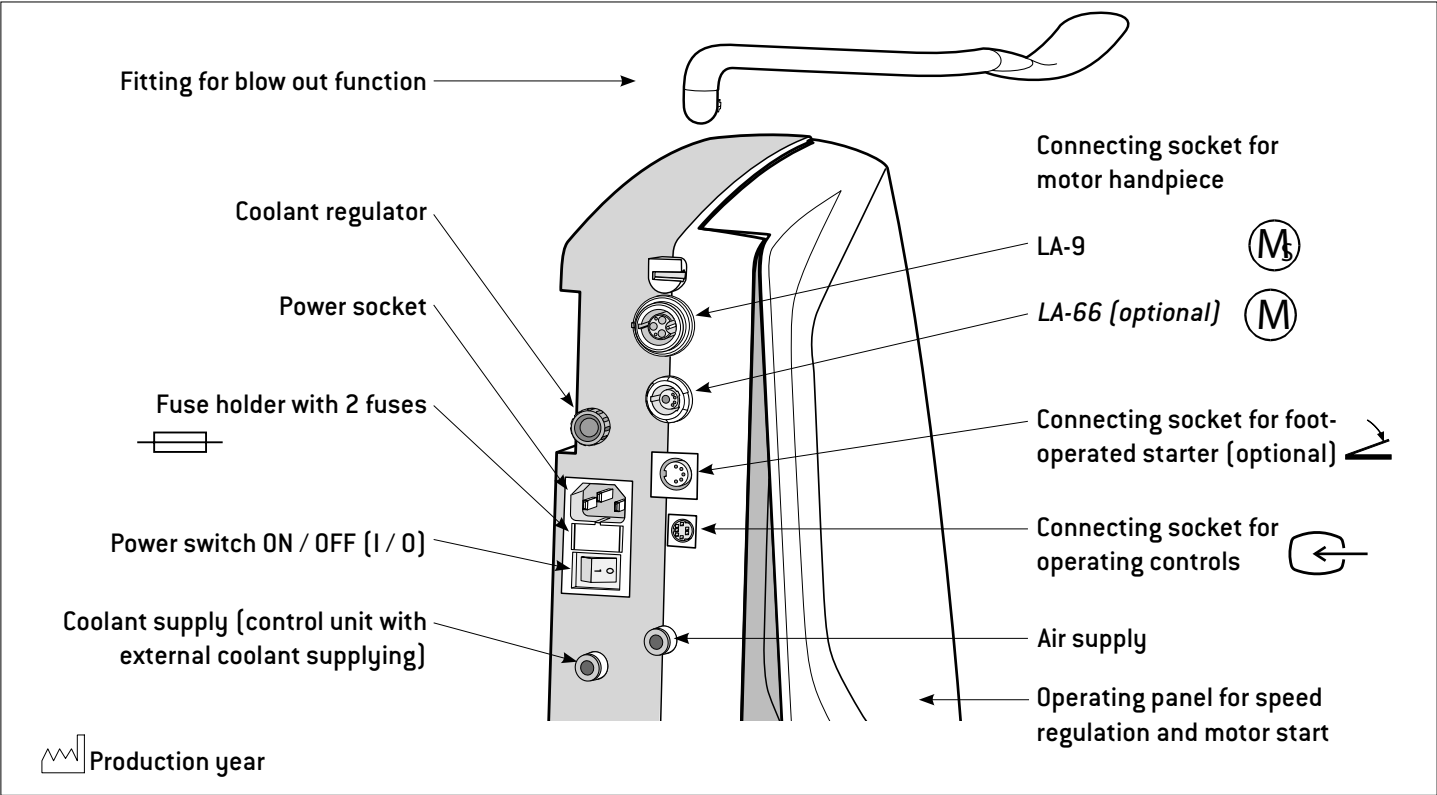

Knee control unit assembly

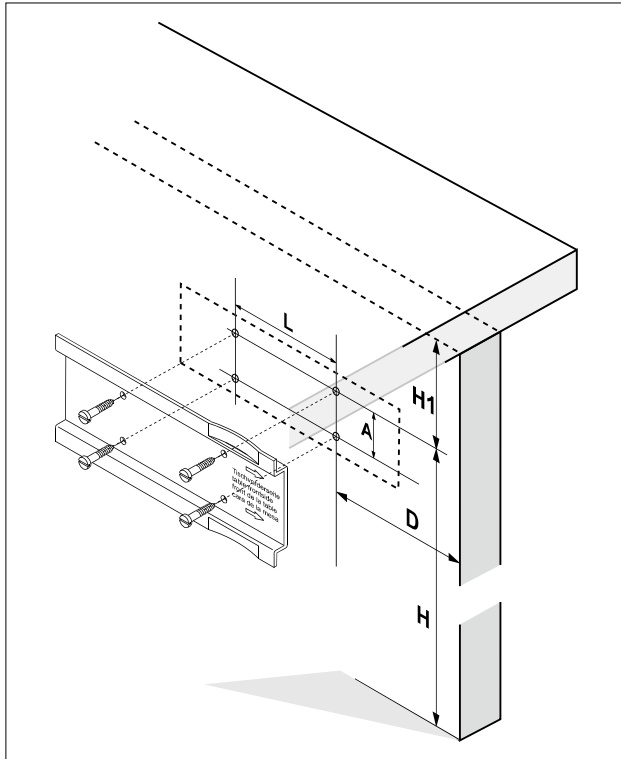

- ➊ Mark the screw holes with the enclosed drilling template or holding plate.
- ➋ Pre-drill 4 screw holes with \varnothing 3 mm.

Note dimensions:

H = 550 to 600 mm

H1 = at least 90 mm

D = 90 mm [control unit with external coolant supplying]
125 mm [control unit with internal coolant supplying]
measured from the front edge of the bench

L = 100 mm

A = 40 mm

Knee control unit operation

 Before connect or disconnect mains cable, motor cable, operating controls, foot-operated starter (optional), air hose, coolant hose (control unit with external coolant supplying) switch off the control unit.

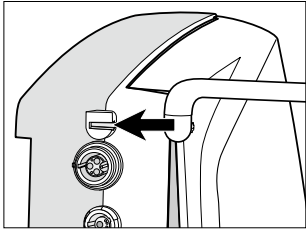

1 Push in the fitting for the blow out function up to the limit stop.

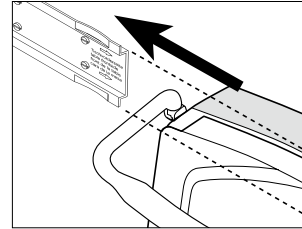

3 Insert control unit up to the limit stop on the holding plate.
 One drop of oil makes insertion easier.

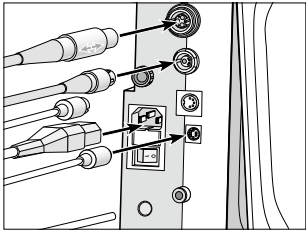

2 Connect the motor cable, operating controls, air hose, foot-operated starter (optional), coolant hose (control unit with external coolant supplying) and mains cable.

 Note the positioning!

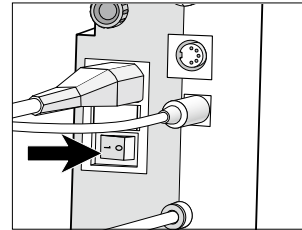

4 Switch on control unit (I).

6. Description of table control unit with internal coolant supplying

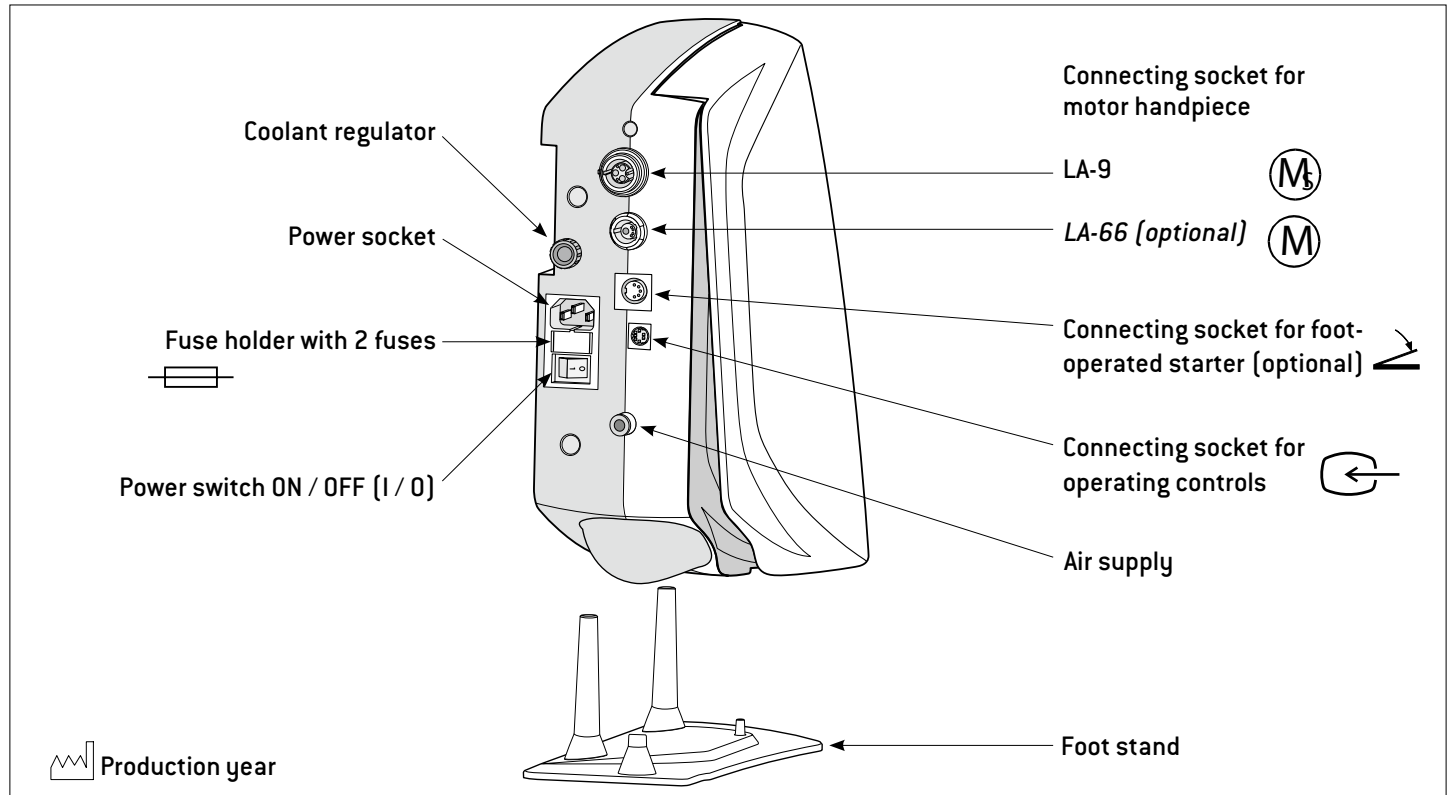

Description of table control unit with external coolant supplying

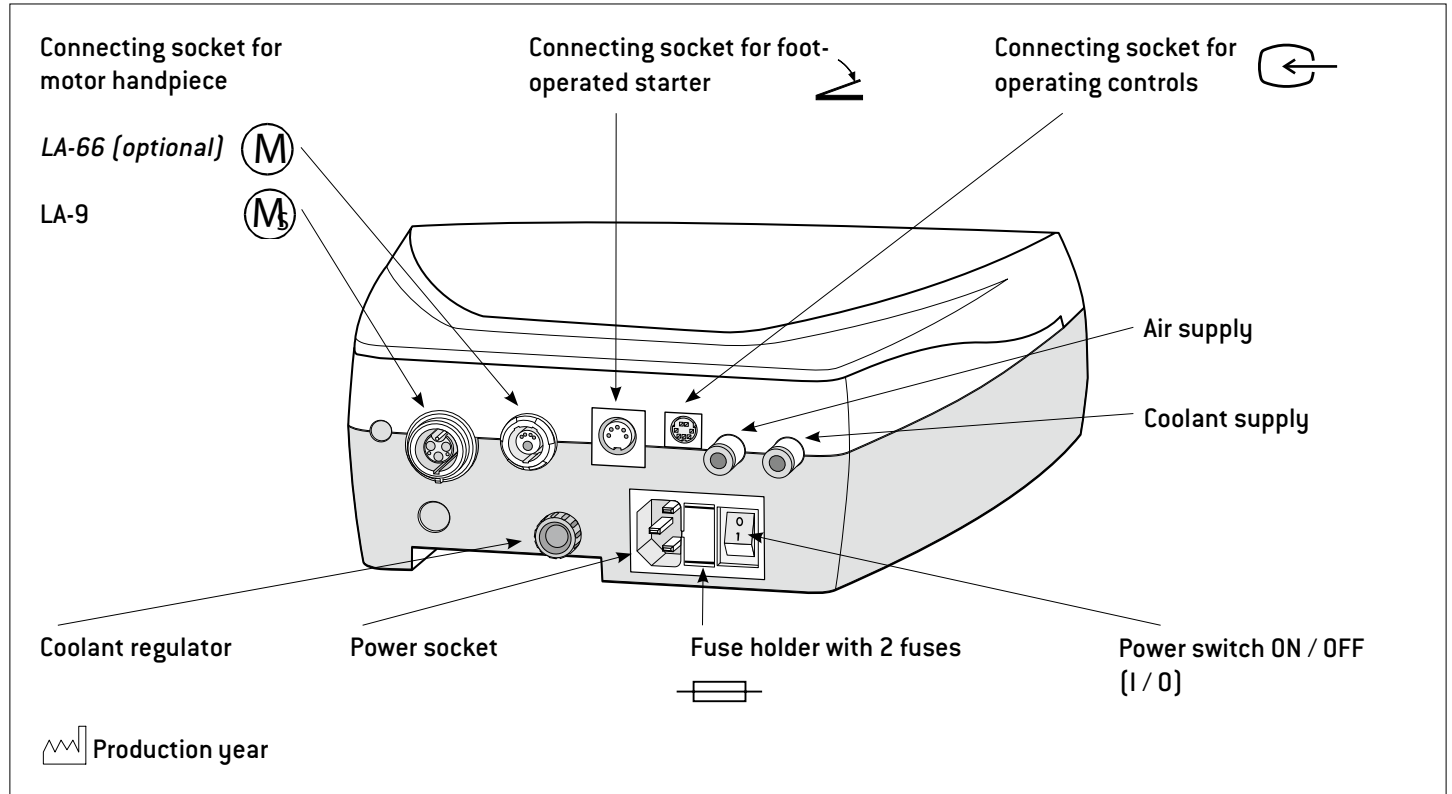

Starting operation – Table control unit

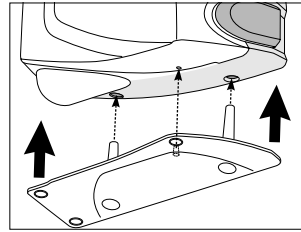
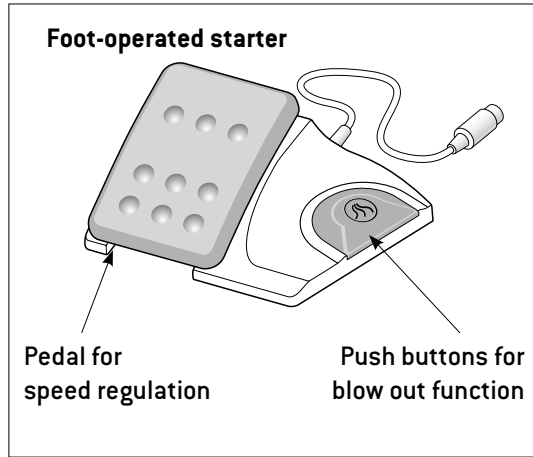

- 1 Assemble the control unit onto the foot stand with compressed operating panel (control unit with internal coolant supplying).

 Note the positioning!

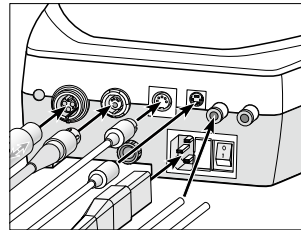

- 2 Connect the motor cable, operating controls, foot-operated starter, air hose, coolant hose (control unit with external coolant supplying) and mains cable.

 Note the positioning!

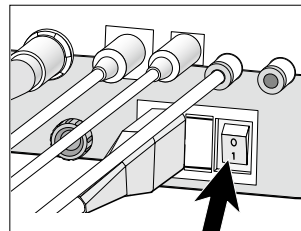

- 3 Switch on control unit (I).

 Before connect or disconnect mains cable, motor cable, operating controls, foot-operated starter, air hose, coolant hose (control unit with external coolant supplying) switch off the control unit.

7. General starting operation – Filling of the coolant tank

-  By ventilation at the first filling or if the coolant tank was emptied completely during work, it can coming to delays in coolant escaping.
W&H recommend the use of distilled water.

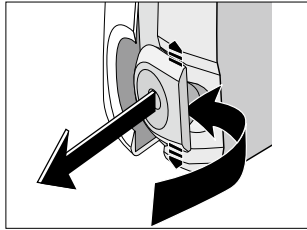

- ❶ Pull out the coolant tank.

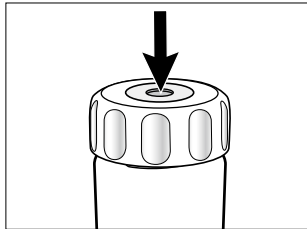

- ❷ Ventilate the coolant tank by putting pressure on the valve.

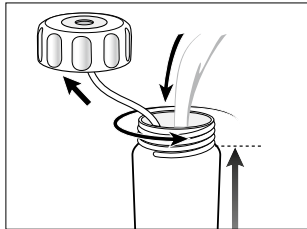

- ❸ Open the coolant tank and fill in the coolant.

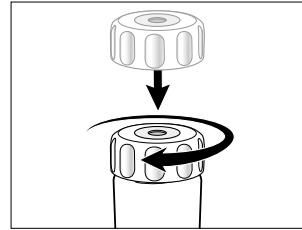

- ❹ Close the coolant tank.
 Pressure build-up in the coolant tank

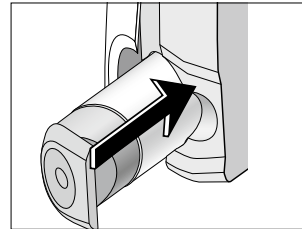

- ❺ Push in the coolant tank until it engages audibly.
 Only insert a deaerated coolant tank.

General starting operation – Regulating coolant

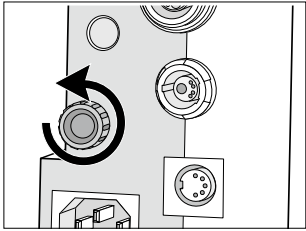

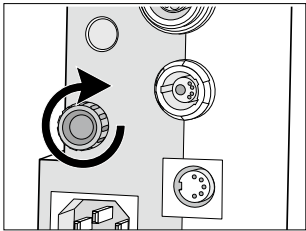

❶ Increase coolant.

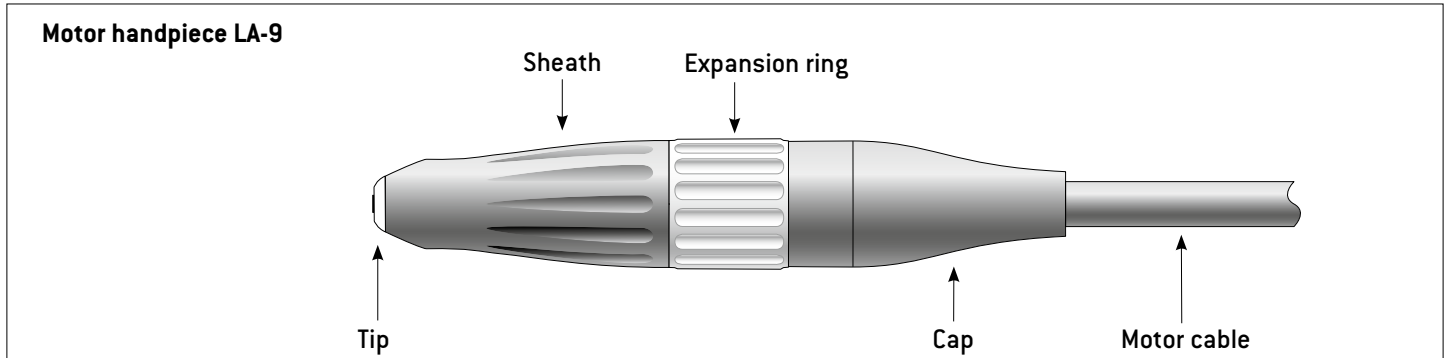

❷ Decrease coolant.

8. Description of the motor handpiece LA-9 / Adaptor for milling device (optional)



 The milling device adaptor (optional) for the motor handpiece can be fastened above or below the expansion ring. The milling device adaptor (optional) has a diameter of 16 or 18 mm on either side for use with different milling devices.

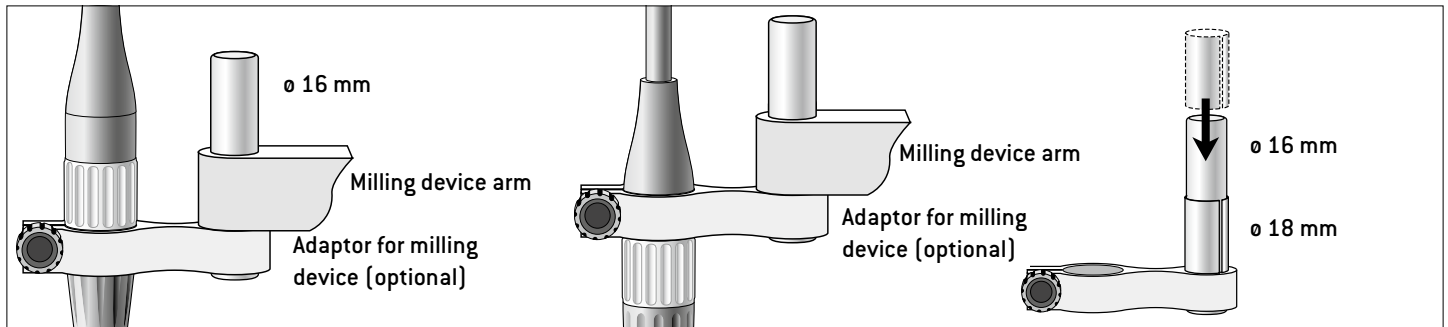

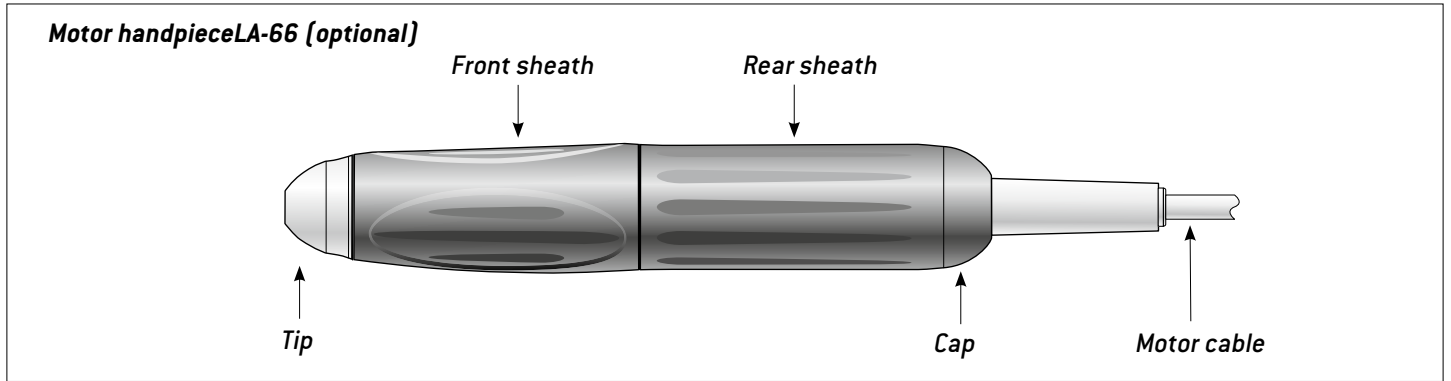

Description of the motor handpiece LA-66 (optional)

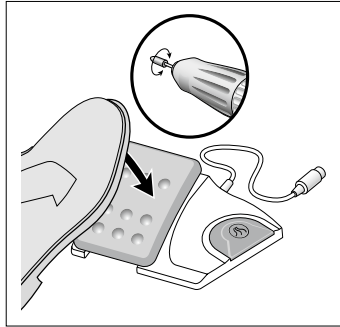
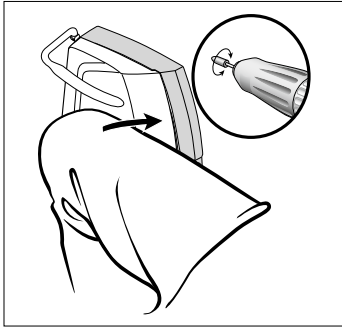

9. General operation – start motor handpiece / blow out function

 Start motor handpiece by pressing the knee control unit or the foot-operated starter.



 Activate the blow out function by constantly pressing the button or fitting.

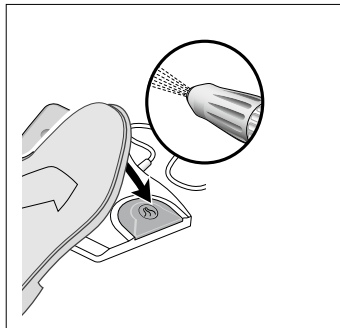
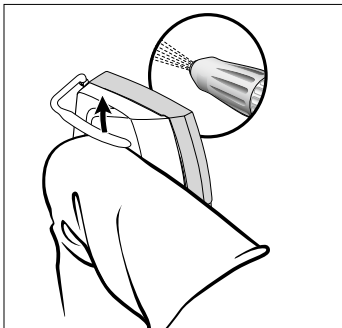

10. Description of operating controls

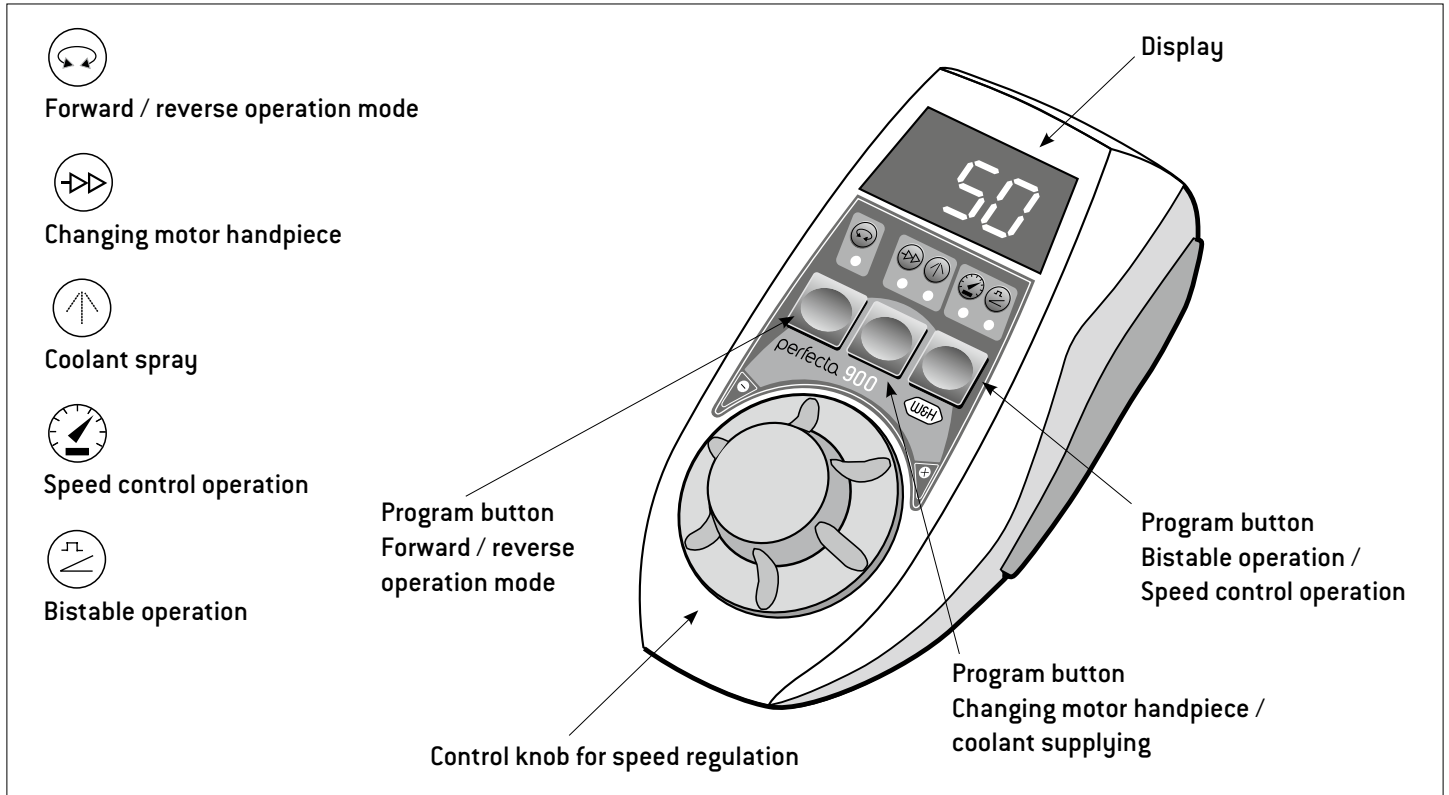

Description of the operating controls – Assemble support (optional)

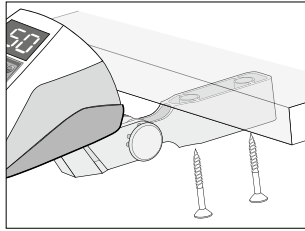
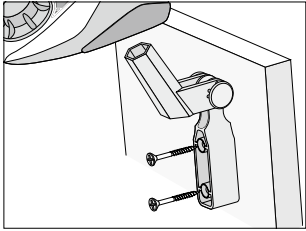

❶ Assemble the support (optional).

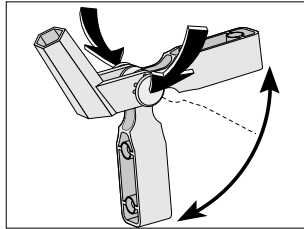

❷ The support (optional) can be moved into a variety of assembly positions by simultaneously pressing both buttons on the joint.

11. Operating controls – Reverse operation mode

 You can switch between forward and reverse operation by pressing the program button. When switching to reverse operation, an audible signal sounds and the LED illuminates.

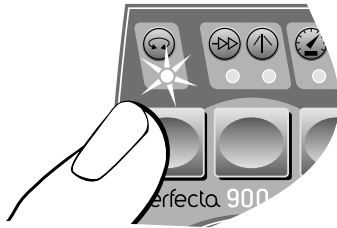

Operating controls – Changing the speed

 By turning the PLUS / MINUS control knob, the values 5.000 – 80.000 rpm [LA-66 (optional) 1.000 – 40.000 rpm] are continuously increased / decreased.

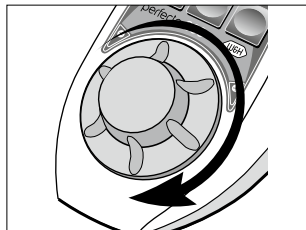

1 Increase speed.

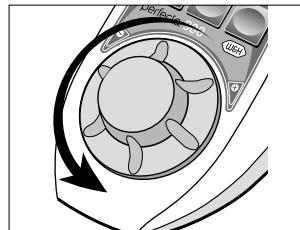

2 Decrease speed.

 Set the speeds from 80.000 – 100.000 rpm [LA-66 (optional) 40.000 – 50.000 rpm].

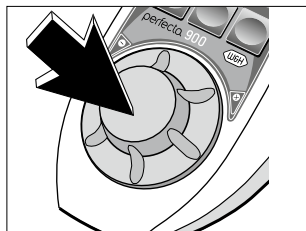

1 Press the control knob.

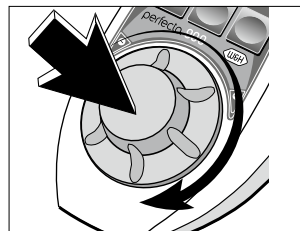

2 Keep the control knob pressed down and turn it.

 Pre-selected maximum speed must not be exceeded during motor start.

Operating controls – Changing motor handpiece / Coolant supplying

 By deactivation of the program button it can be changed to motor handpiece *LA-66 [optional]*.

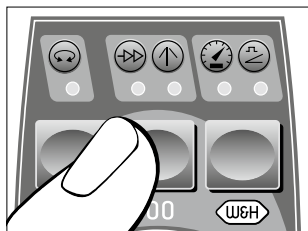

- 1 Keep the program button pressed after approx. 2 seconds, an audible signal sounds. No LED illuminates.

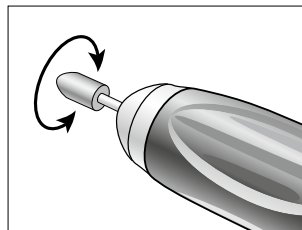

- 2 Start motor handpiece by pressing the pedal or flap.

 At the change on motor handpiece LA-9 the coolant spray becomes co-activated automatically. Deactivating resp. activating the coolant spray: press program button x 1.

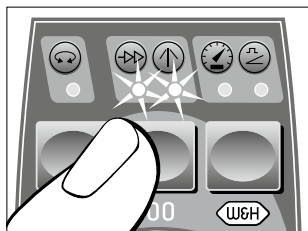

- 1 Keep the program button pressed after approx. 2 seconds, an audible signal sounds. Both LEDs illuminate.

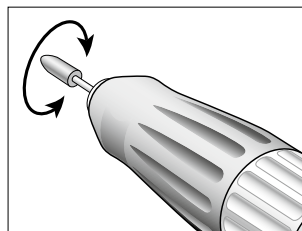

- 2 Start motor handpiece by pressing the pedal or flap.

Operating controls – Bistable operation



During bistable operation, the selected maximum speed is automatically reached during motor start. The motor handpiece runs independently.



Deactivation of bistable operation: Press program button x 2.



- 1 Press the button.
The LED illuminates.

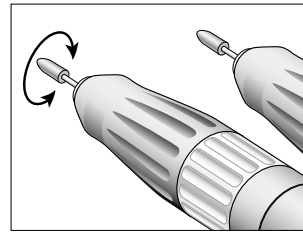

- 3 Start or stop the motor handpiece by tapping the pedal or flap.

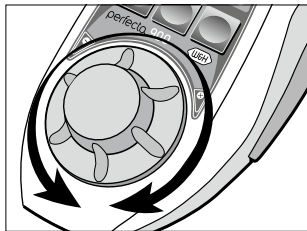

- 2 Set the speed.

Operating controls – Speed control operation



During speed control operation, the controlled speed is saved and automatically maintained.

The motor handpiece runs independently.



Deactivation of speed control operation: Press the program button x 1.

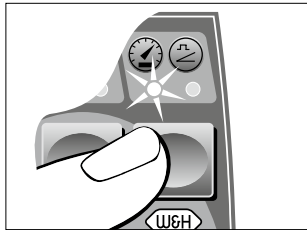

- 1 Press the button x 2.
LED illuminates.

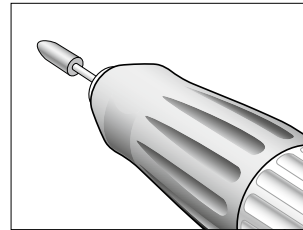

- 3 Stop the motor handpiece by tapping the pedal or flap.

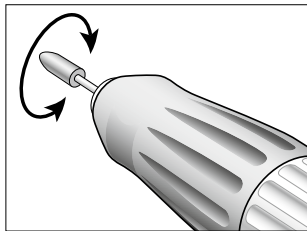

- 2 Start the motor handpiece until the required speed is reached.
After approx. 2 seconds, an audible signal sounds and the required speed is saved.

12. Removing and assembling the motor handpiece

LA-9

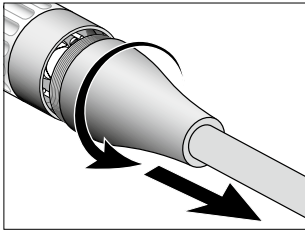

① Unscrew the cap.

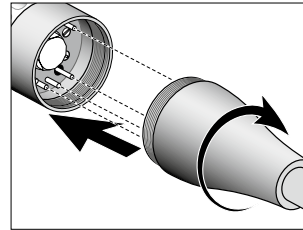

② Assemble and tighten the cap.
Note the positioning!

LA-66 (optional)

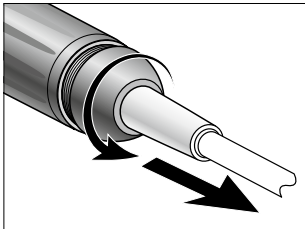

① Unscrew the cap.

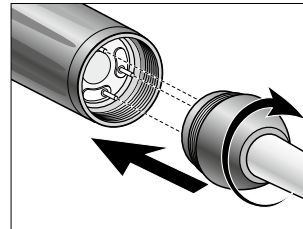

② Assemble and tighten the cap.
Note the positioning!

13. Change the rotary tool

LA-9

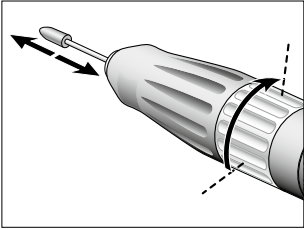

- 1 Turn the expansion ring clockwise up to the limit stop. Push in the rotary tool up to the limit stop or remove.

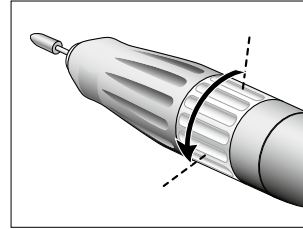

- 2 Turn the expansion ring anti-clockwise until it engages audibly.

LA-66 (optional)

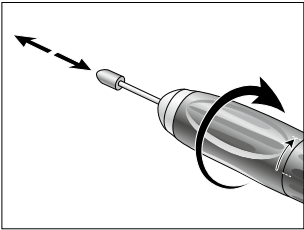

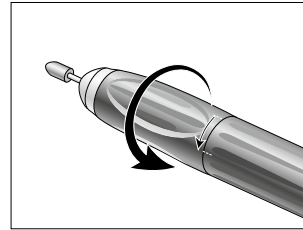

- 1 Turn the front sheath clockwise up to the limit stop. Push in the rotary tool up to the limit stop or remove.

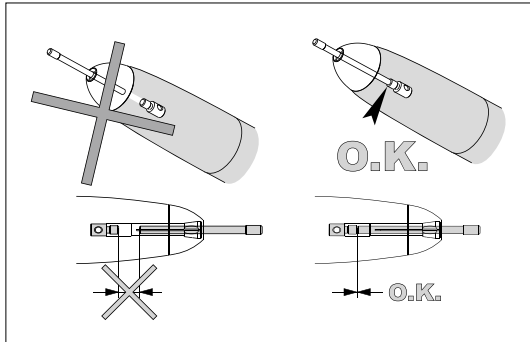

- 2 Turn the front sheath anti-clockwise until it engages audibly.

Change the rotary tool



 When the chuck is open, the motor handpiece is blocked. In the event that the motor handpiece starts accidentally, the electronic system switches off.

Test run

- > Start the motor handpiece.
- > In the event of malfunctions (e.g. vibrations, unusual noises, overheating), stop the motor immediately und contact an authorized W&H service partner (see page 45).

14. Cleaning



The cleaning of the Perfecta (control unit), motor handpiece, operating controls (optional), foot-operated starter (optional) can take place by means of a dry cloth.

15. Cleaning / changing the chuck LA-66 (optional)

 Chuck key, spanner, cleaning brush are located on the underside of the handpiece holder.

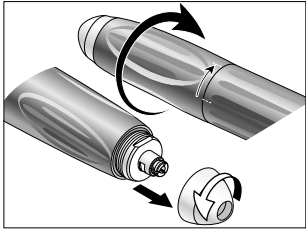

- 1 Turn the front sheath clockwise up to the limit stop.
Unscrew the tip anti-clockwise.

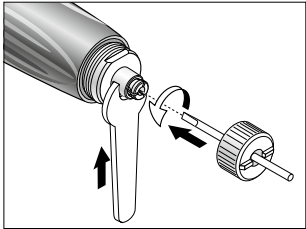

- 2 Insert the chuck key up to the limit stop in the chuck and unscrew anticlockwise.
 Hold the shaft firmly with the spanner.

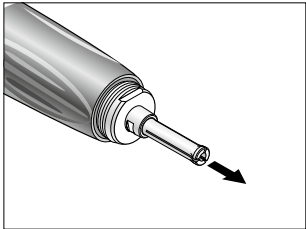

- 3 Remove the chuck.

Cleaning / changing the chuck

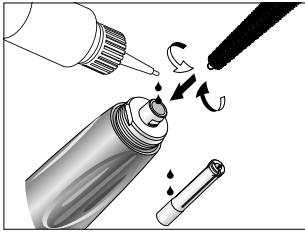

- 1** Clean the inside and outside of the shaft using the cleaning brush.
Apply 2 drops of oil into the hole in the shaft and outside of the chuck.

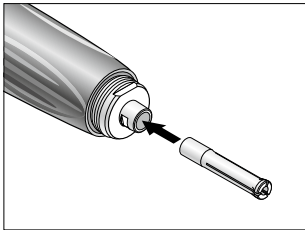

- 2** Insert the chuck.

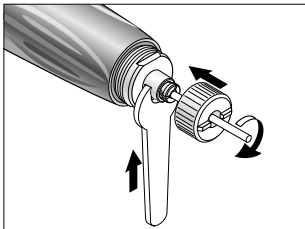

- 3** Insert the chuck key up to the limit stop in the chuck and screw clockwise.
 Hold the shaft firmly with the spanner.

16. Error messages (as shown on display)

Error No.	Description	Remedy
E00	Electronics overheating – safety shutdown	Switch off the equipment, cool for at least 10 minutes and then re-start
E01	Motor handpiece overloading – Drive blocked	Connect motor handpiece or close the chuck mechanism
E07	Foot-operated starter error initialising	Switch off the equipment, re-start, do not activate the foot / knee control when switching on
E09	Foot-operated starter error Speed regulator (foot / knee control unit) error	Switch off the equipment, check the connection of the foot control, restart
E19	Run limiting control	Switch off the equipment and re-start
E99	System failure	Switch off the equipment and re-start



If one of the error messages described above cannot be rectified by switching off Perfecta and then switching it on again, the device must be checked by an authorized W&H service partner [see page 45]. If a total failure of the equipment occurs caused by external circumstances, the equipment must be switched off and then on again.

17. W&H Accessories

Use only original W&H accessories / spare parts
or accessories approved by W&H

03211500	Handpiece holder
04014700	Fuse T1.25L
01199100	Fuse T2A
05117800	Motor cable 1,8 m LA-9
05015900	Motor handpiece LA-9 (without motor cable)
05038100	Foot-operated starter L-NV
05075600	Hose for coolant supply
05138000	Support for operating controls (optional)
05243400	Operating controls LA-9D
05250400	Hose for air supply
06319400	Adaptor for milling device (optional)
05116500	<i>Motor cable 1,8 m LA-66</i>
05201200	<i>Motor handpiece LA-66 (without motor cable)</i>
00669400	<i>Cleaning brush</i>
03202800	<i>Spanner</i>
03304500	<i>W&H Service oil</i>
01125900	<i>Chuck key ø 2,35 mm</i>
01126000	<i>Chuck key ø 3 mm</i>
03205500	<i>Chuck ø 2,35mm</i>
03205600	<i>Chuck ø 3 mm</i>

18. Servicing

Repairs

If a defect occurs, always return all the equipment, due to the fact that with motor malfunctions, an inspection of the electronic controls is also necessary!

We recommend that only an authorized W&H service partner should undertake this servicing and checking.

Returns

- > Refer all questions to an authorized W&H service partner (see Page 45).
- > Always return equipment in the original packaging!
- > Do not coil the cable around the motor handpiece and do not twist or kink the motor cable! (Risk of damage)

Regular checking of Perfecta and accessories

Regular servicing of function and safety including the accessories is necessary and should be carried out at least once every three years, unless shorter intervals are prescribed by law.

We recommend that only an authorized W&H service partner (see page 45) should undertake this servicing and checking.

19. Technical Data

Perfecta 900 with motor handpiece	LA-9	LA-66 (optional)
Mech. output power	30 W	160 W
Torque	0.7 Ncm	7.8 Ncm
Speed	5,000 – 100,000 rpm	1,000 – 50,000 rpm
Power input		200 W
Supply voltage		100 – 130 VAC / 220 – 240 VAC
Rated current		0.2 – 1.6 A / 0.1 – 0.8 A
Supply fuse		250 V – T2A / 250 V – T1.25L
Voltage tolerance		+/- 10 %
Frequency		50 – 60 Hz
Operating mode	S6 (4/10min) Continuous operation with intermittent loading	
Noise		< 55 dBA
Vibration		< 2,5 m/s ²
Height / width / depth and weight with internal coolant supplying:		
Knee control unit	without lever: 306 / 128 / 317 mm, with lever: 306 / 187 / 340 mm and 6.0 kg	
Table control unit	317 / 116 / 317 mm and 6.3 kg	
Height / width / depth and weight with external coolant supplying:		
Knee control unit	without lever: 236 / 108 / 282 mm, with lever: 236 / 187 / 304 mm and 5.5 kg	
Table control unit	88 / 236 / 282 mm and 5.8 kg	
Blown out air pressure (input)		max. 6 bar (87 psi / 600 kPa)
Coolant supply (input)		max. 2 bar (29 psi / 200 kPa)
Chuck diameter	1,6 mm	2,35 / 3,0 mm
Bur concentricity accuracy		≤ 0,02 mm

Technical Data

Physical characteristics

Temperature in storage:

-40 °C [-40 °F] to +70 °C [+158 °F]

Air humidity in storage:

8 % to 80 % [relative], non-condensing

Temperature in operation:

+5 °C to +40 °C

Air humidity in operation:

maximum 80 % [relative] with a temperature of up to +31°C, decreasing arithmetically up to a maximum of 50 % [relative] with a temperature of up to +40°C

Pollution degree:

2

Overvoltage degree:

II

Altitude:

up to 2,000 m above sea level

20. Recycling and Disposal

Recycling

W&H considers that it has a special duty towards the environment. The Perfecta equipment along with its packaging has been designed to be as environmentally friendly as possible.



Disposal of the Perfecta (control unit), operating controls, foot-operated starter, motor handpiece

Follow your country-specific laws, directives, standards and guidelines for the disposal of used electrical devices.

Disposal of the packaging material

All packaging materials have been selected according to environmentally compatible and disposal aspects and can be recycled. Please send old packaging materials to the relevant collection and reprocessing system. In this way, you will contribute to the recycling of raw materials and the avoidance of waste.

Explanation of warranty terms

This W&H product has been manufactured with great care by highly qualified specialists. A wide variety of tests and controls guarantee faultless operation. Please note that claims under warranty can only be validated when all the directions in the Instructions for use have been followed.

As manufacturer, W&H is liable for material or manufacturing defects within a warranty period of 24 months from the date of purchase.

We accept no responsibility for damage caused by incorrect handling or by repairs carried out by third parties not authorized to do so by W&H!

Claims under warranty – accompanied by proof of purchase – must be sent to the vendor or to an authorized W&H service partner. The provision of service under warranty extends neither the warranty period nor any other guarantee period.

24 months warranty

CE-Declaration of conformity

PEOPLE HAVE PRIORITY



EU Declaration of Conformity

W&H DENTALWERK BÜRMOOS GmbH
 Ignaz-Glaser-Straße 53
 A-5111 Bürmoos / Austria

hereby declares that the following products:

Name: Dental laboratory units
 Product name: Perfecta 300/600/900
 Type: as page 2
 Ref. no.: as page 2
 Serial no.: as page 2

conform to the following applicable regulations in the series production design:

Machinery Directive 2006/42/EU
Electromagnetic Compatibility Directive 2014/30/EU
ROHS – Directive 2011/65/EU

During the design and manufacture of the products, the following harmonized standards were applied:

ISO 9001:2008, EN ISO 12100:2010, EN 1041:2008 + A1:2013, EN ISO 780:2015,
 EN ISO 1043-1:2011, IEC 61010-1:2010, EN 61326-1:2013

This declaration of conformity is issued under the sole responsibility of the manufacturer.

Authorized for the compilation of technical documents:
 Johann Fersterer, Ignaz-Glaser-Str. 53, A-5111 Bürmoos

Bürmoos, 19.04.2016

Johann Fersterer
 Project Sponsor

MEL0004_02

1 / 2

Type	Ref. no.	Serial no. (from)
LA-323 T	14933000	04594
LA-315 T	14933001	01361
LA-323 TE	14933002	04594
LA-315 TE	14933003	01361
LA-323 K	14933100	02580
LA-315 K	14933101	01068
LA-323 KE	14933102	02580
LA-315 KE	14933103	01068
LA-323 F	14933200	04426
LA-315 F	14933201	01207
LA-323 FE	14933202	04426
LA-315 FE	14933203	01207
LA-623 T	14936000	01791
LA-615 T	14936001	01028
LA-623 K	14936100	02702
LA-615 K	14936101	01041
LA-623 F	14936200	01597
LA-615 F	14936201	01008
LA-923 T	14939000	01056
LA-915 T	14939001	01009
LA-923 K	14939100	01060
LA-915 K	14939101	01002
LA-923 TT	14939300	01976
LA-915 TT	14939301	01067
LA-923 KT	14939400	01875
LA-915 KT	14939401	01026

MEL0004_02

2 / 2

Authorized W&H service partners

Find your nearest W&H service partner at <http://wh.com>

Simply go to the menu option »Service« for full details.

Alternatively please contact:

W&H (UK) LIMITED, Unit 6, Stroud Wood Business Centre, Park Street, St Albans, Hertfordshire AL2 2NJ, United Kingdom
t + 44 1727 874990, f + 44 1727 872254, E-Mail: technical.uk@wh.com

W&H Impex Inc., 6490 Hawthorne Drive, Windsor, Ontario, N8T 1J9, Canada
t + 1 800 2656277, 1 519 9446739, f + 1 519 9746121, E-Mail: service.ca@wh.com

W&H Impex Inc., 14300 Henn Rd., Dearborn, MI 48126, USA
t + 1 800 2656277, 1 519 9446739, f + 1 519 9746121, E-Mail: service.us@wh.com

A-DEC AUSTRALIA CO. INC., Unit 8, 5-9 Ricketty Street, Mascot NWS 2020, Australia
t + 61 2 83324000, f + 61 2 83324099, E-Mail: a-dec@a-dec.com.au

Manufacturer

W&H Dentalwerk Bürmoos GmbH
Ignaz-Glaser-Straße 53, 5111 Bürmoos, Austria

t +43 / 6274 / 6236-0, **f** +43 / 6274 / 6236-55
office@wh.com **wh.com**

Form-Nr. 50596 AEN
Rev. 011 / 19.04.2016
Subject to alterations

